



Installation instructions

Door control

TS 970

Automatic control

Version: 51171582

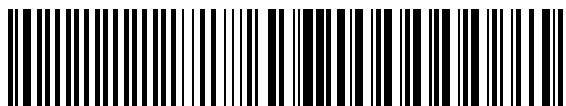

0000000 0000 51171582 XXXXX

– en –

Version: i / 01.2020



GfA ELEKTROMATEN GmbH & Co. KG
Wiesenstraße 81 • 40549 Düsseldorf

🌐 www.gfa-elektromaten.de
✉ info@gfa-elektromaten.de

Contents

1	General safety information	6
2	Technical data	7
3	Mechanical installation	8
4	Electrical installation	9
	Connection cable connection overview	10
	Limit switch configuration, screwable version up to year of construction in 1997	11
	Limit switch configuration, single limit switches	11
	Carrying out the electrical installation	12
	Mains supply	13
	Mains connection to control	13
	Completing the electrical installation	13
	Overview of control	14
5	Starting up the control	15
	DES: Rapid adjustment of final limit positions	15
	NES: Rapid adjustment of final limit positions	16
6	Electrical installation – control accessories	17
	Connection of door safety switches X2	17
	Connection of safety devices X2	18
	External supply X1	19
	Emergency STOP X3	19
	Automatic closing, On/Off X4	19
	External control device X5	19
	Photo cell X6	19
	Light curtain X6	20
	Radio receiver X7	20
	Pull switch X7	20
	Intermediate open X8	20
	Traffic light X20	20
	Magnetic brake X20	20
7	Control programming	21
8	Table menu items	22
	Door operating modes	22
	Door positions	23



Door functions	24
Safety functions.....	27
DI / FI settings	28
Maintenance cycle counter.....	29
Readout of Data memory	30
Deleting of all settings / Readout GfA stick	30
9 Safety devices.....	31
X2: Input, door safety switch	31
X2: Input for safety devices	33
Installation of the spiral cable	34
EMERGENCY operation	37
X3: Input, emergency STOP	37
10 Functional description	38
X: 24 VDC voltage supply	38
X1: Mains supply of the control and supply of external devices	38
X4: Input, automatic closing Off/On.....	39
X5: Input, control device.....	39
X6: Input „Through / reflective photo cell“ resp. light curtain	40
X7: Input pull switch/radio receiver.....	43
X8: Input, intermediate stop On/Off.....	44
Potential-free X20 relay contact	45
Force monitoring (DES only)	45
Travel time monitoring (NES only).....	46
UBS system	47
UBS connection	47
Reversing duration adjustment.....	47
Maintenance cycle counter.....	48
Short-circuit/overload display	48
Standby function	48
11 Status display.....	49
Faults	49
Commands.....	53
Status indications	54
12 Explanation of symbols	55

Symbols



Warning - Risk of injury or danger to life!



Warning - Danger to life from electrical current!



Note - Important information!



Prompt - Required action!

Illustrations show example products. Differences from the delivered product are possible.

1 General safety information

Specified normal use

The door control is intended for a power-operated door with a drive unit (NES/DES GfA limit switch system).

The safe operation is only guaranteed with specified normal use. The drive unit is to be protected from rain, moisture and aggressive ambient conditions. No liability for damage caused by other applications or non-observance of the information in the manual.

Modifications are only permitted with the agreement of the manufacturer. Otherwise the Manufacturer's Declaration shall be rendered null and void.

Safety information



Warning ! Failure to follow these installation instructions may result in severe injury or death.

- Please read these instructions before using the product
- Keep these instructions handy
- Please include these instructions when you pass on the product

Installation and commissioning are to be performed by skilled personnel only.

Only trained electrical craftsmen are permitted to work on electrical equipment. They must assess the tasks assigned to them, recognise potential danger zones and be able to take appropriate safety measures.

Installation work is only to be carried out with the supply off.

Observe the applicable regulations and standards.

Coverings and protective devices

Only operate with corresponding coverings and protective devices.

Ensure that gaskets are fitted correctly and that cable glands are correctly tightened.

Spare parts

Only use original spare parts.

2 Technical data

Series	TS 970	
Dimensions W x H x D	155 mm x 386 mm x 90 mm	
Installation	Vertical, free of vibration	
Operating frequency	50 Hz / 60 Hz	
Supply voltage (+/- 10%)	1 N~220-230 V, PE 3 N~220-400 V, PE 3~220-400 V, PE	
Output power for drive unit, maximum	3 kW	
Protection per phase, on-site	10 A 16 A	
External mains supply: Internal electronic protection	24 V DC 0.18 A	
External mains supply: X1/L, X1/N Protection via F1 micro-fuse	1 N~230 V 1.6 A time-lag	
Control inputs	24 V DC, type. 10 mA	
Relay contact	1 potential-free changeover contact	
Loading of relay contacts, ohmic/inductive	230 V AC, 1 A 24 V DC, 0,4 A	
Control power consumption	11 W	
Temperature range	Operation	-10 °C +50 °C
	Storage	+0 °C +50 °C
Air humidity, non-condensing	up to 93 %	
Protection class of housing with CEE-plug	IP 54 / IP 65	
Protection class of housing	IP 65	
Compatible GfA - limit switch	NES (mechanical limit switch) DES (digital limit switch)	

3 Mechanical installation



Control installation!

- Indoor use only
- Mounting only on even ground that is free of vibration
- Only mount in the vertical position
- Door must be in clear view from place of installation

Requirements

The permissible loads on walls, mountings, connection and transmission elements must not be exceeded.

Mounting

The control is mounted via 4 elongated holes

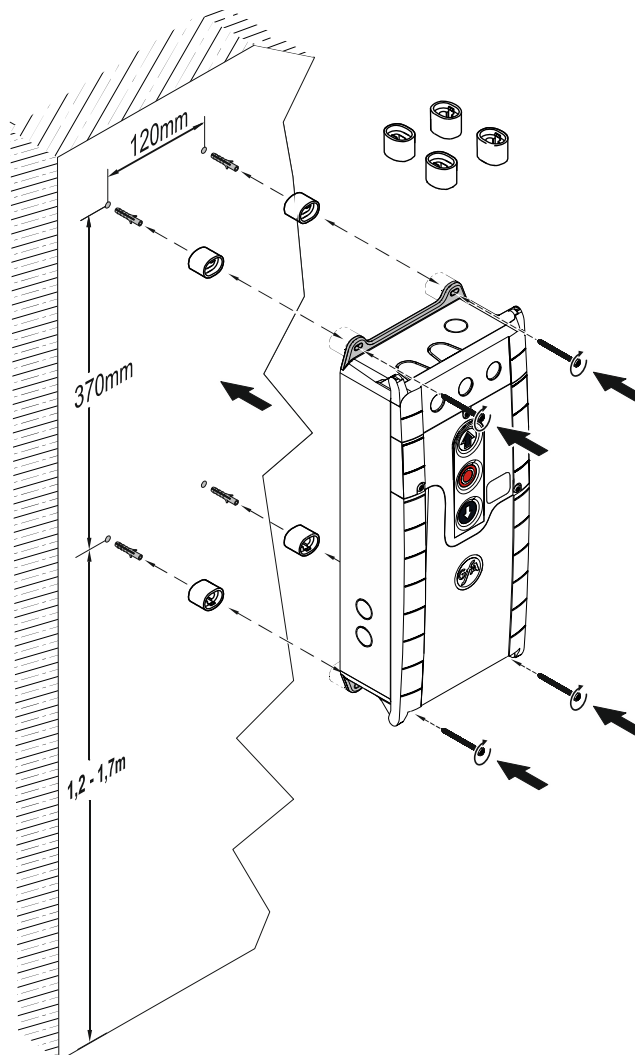

4 Electrical installation



Warning - Danger to life due to electrical current!

- Disconnect the cables (mains OFF) and check that the supply is off
- Observe the applicable regulations and standards
- Ensure proper electrical connection
- Use suitable tools



On-site backup fuse and disconnecter unit!

- Only use current sensitive earth leakage circuit breakers type B for FI-drive units
- Connection to the indoor installation via an all-pole disconnecter unit, with current ≥ 10 A as per EN 12453 (e.g. CEE plug connector, main switch)



Note! - The inputs of the following safety devices of the control are rated

Performance Level c (PLc):

- Slack-rope switch
- Pass-door switch
- Safety edge
- Limit switch system
- Safety circuit of the drive unit
- Emergency STOP control device

Connect only sensors that comply with the current EN 12453 and are suitable for Performance Level c.



Observe the installation instructions of the drive unit!

Connection cable connection overview

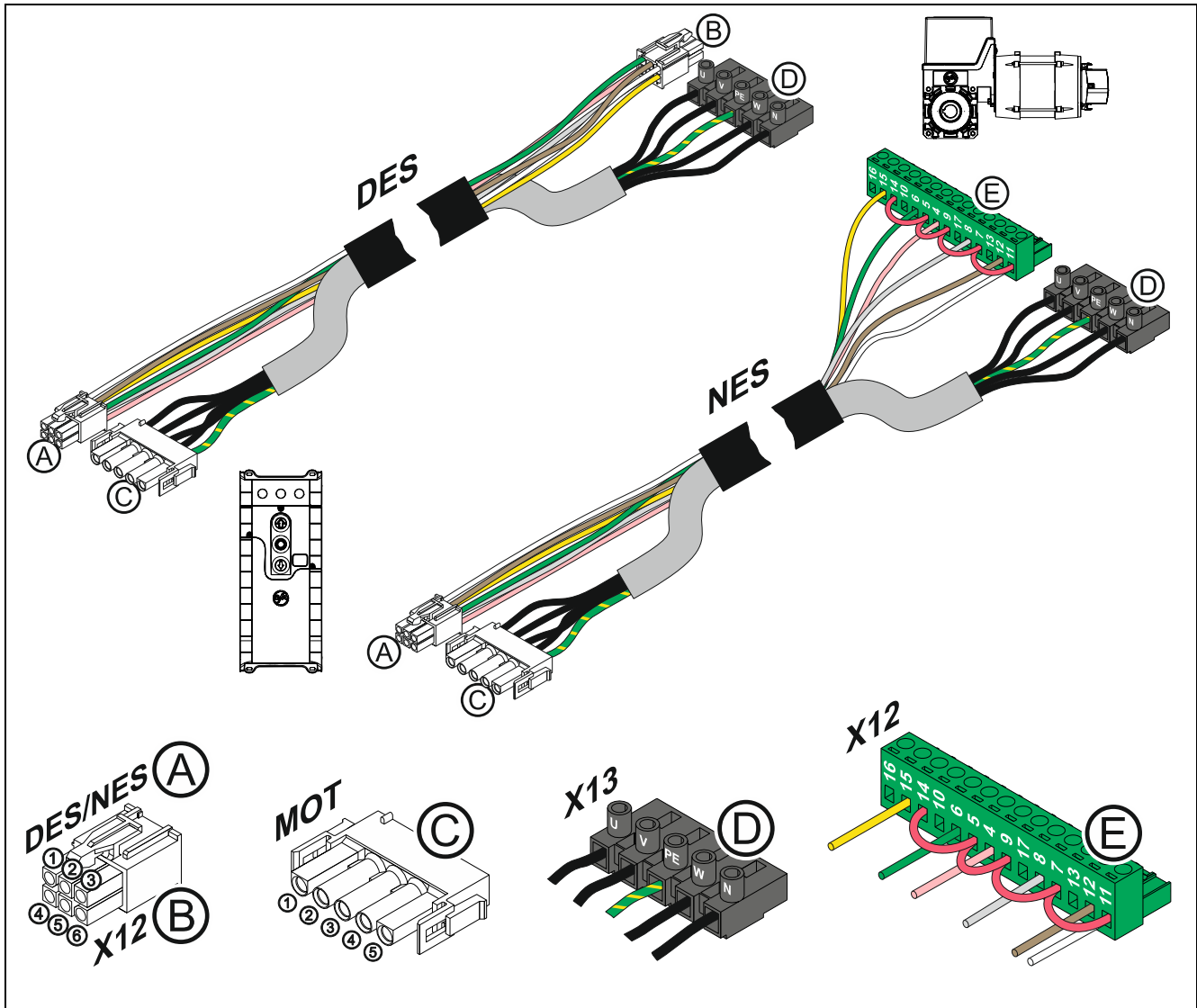

Ⓐ DES →		Ⓑ X12 DES		Ⓒ MOT →		Ⓓ X13	
Pin	Core	Pin	Description:	Pin	Core	Term.	Description:
①	5/wh	①	+24 V safety circuit	①	3	W	Phase W
②	6/bn	②	Channel B (RS485)	②	2	V	Phase V
③	7/gn	③	Ground	③	1	U	Phase U
④	8/ye	④	Channel A (RS485)	④	4	N	Neutral conductor (N)
⑤	9/gy	⑤	Safety circuit	⑤	PE	PE	
⑥	10/pk	⑥	8 V DC supply voltage				

Ⓐ NES →		Ⓔ X12 NES	
Pin	Core	Term.	Description:
①	5/wh	11	Limit switch common +24 V, wire link to: 7, 9, 5, 14
②	6/bn	12	S5 Auxiliary limit switch
③	7/gn	6	S3 Open limit switch
④	8/ye	15	S6 Auxiliary limit switch
⑤	9/gy	8	S4 CLOSE limit switch
⑥	10/pk	4	Safety circuit

Limit switch configuration, screwable version up to year of construction in 1997

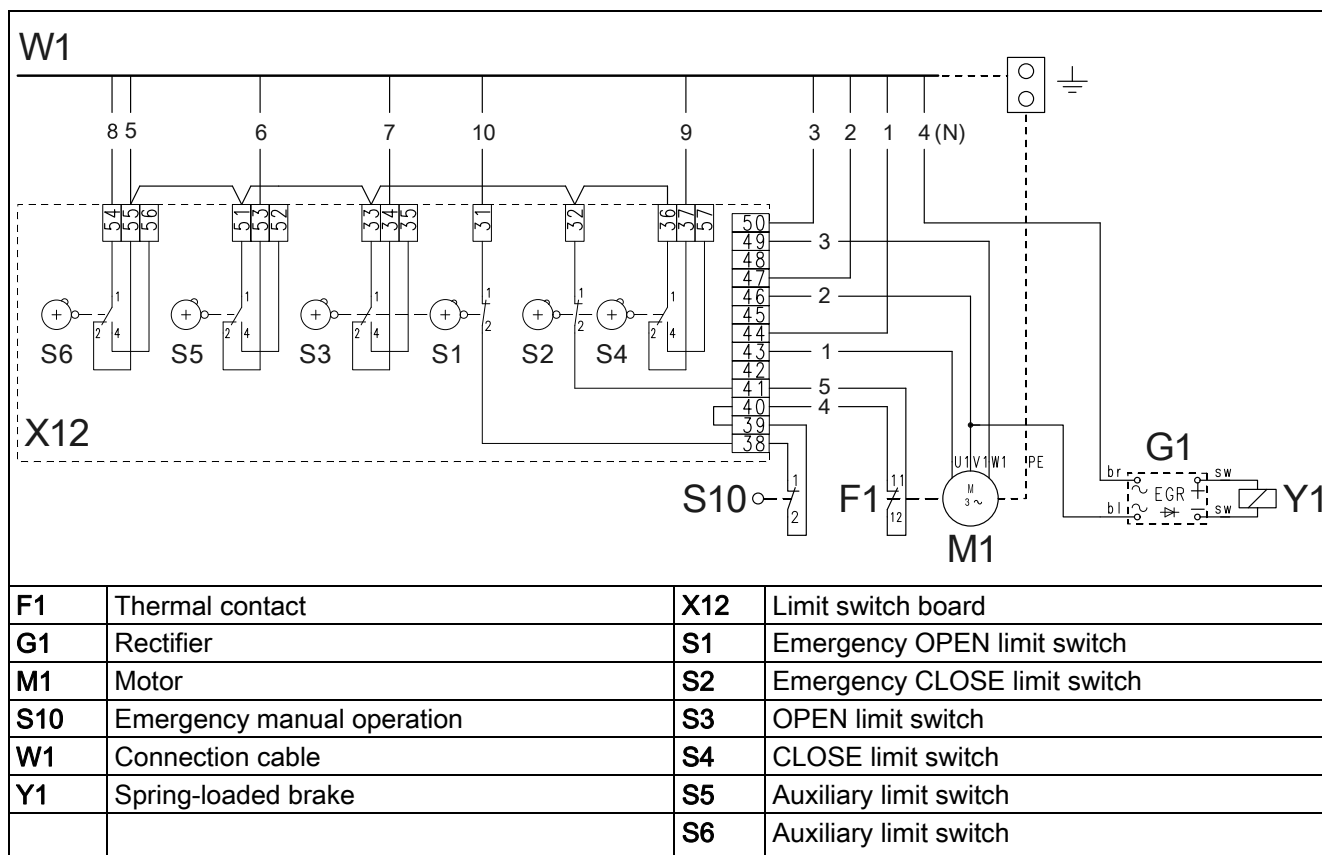

Limit switch configuration, single limit switches

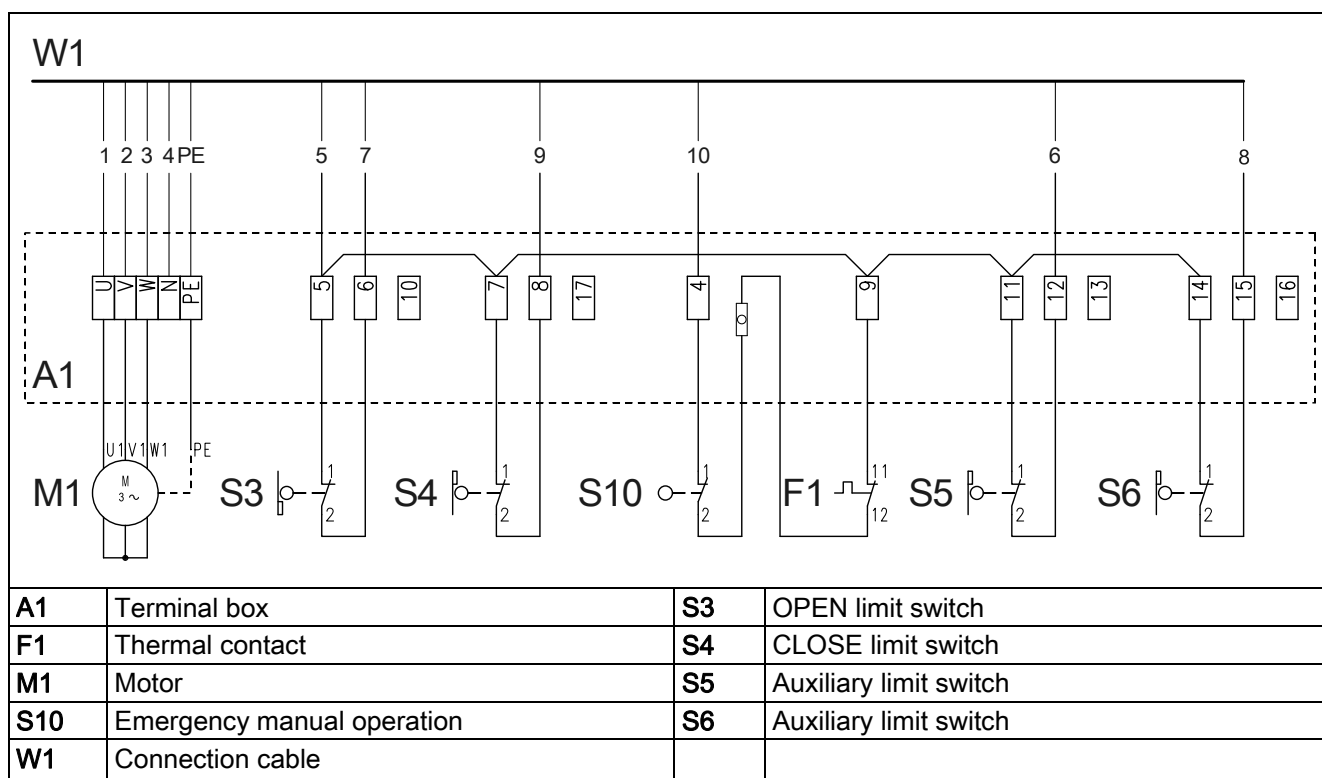

Carrying out the electrical installation

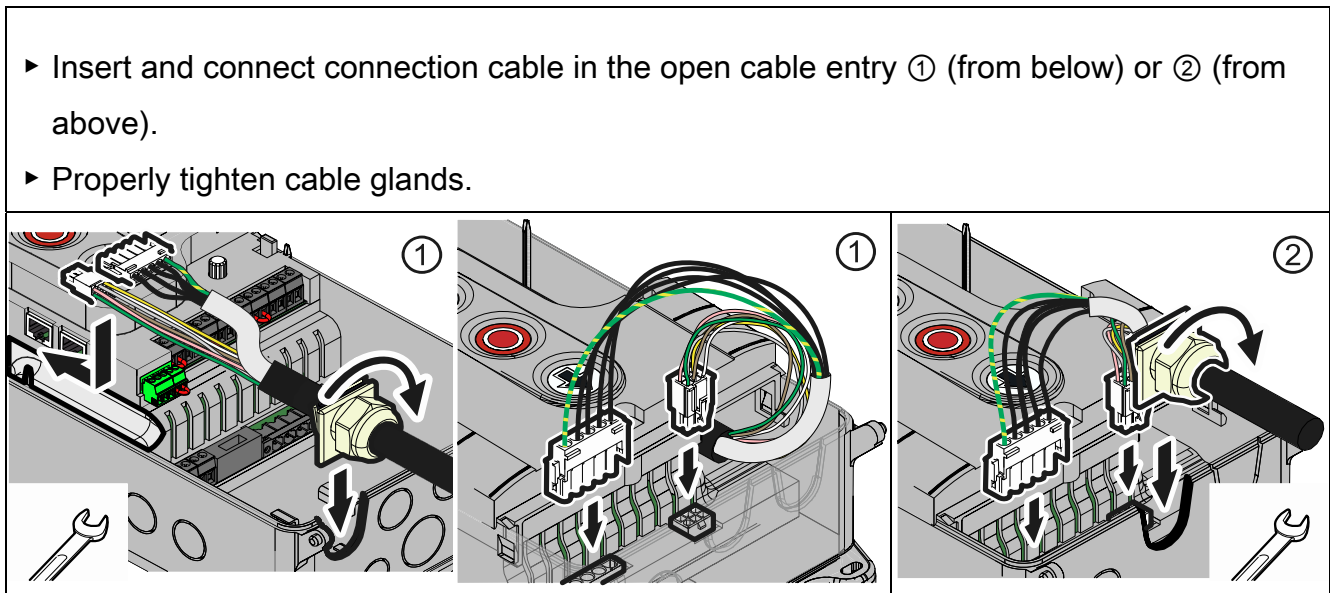
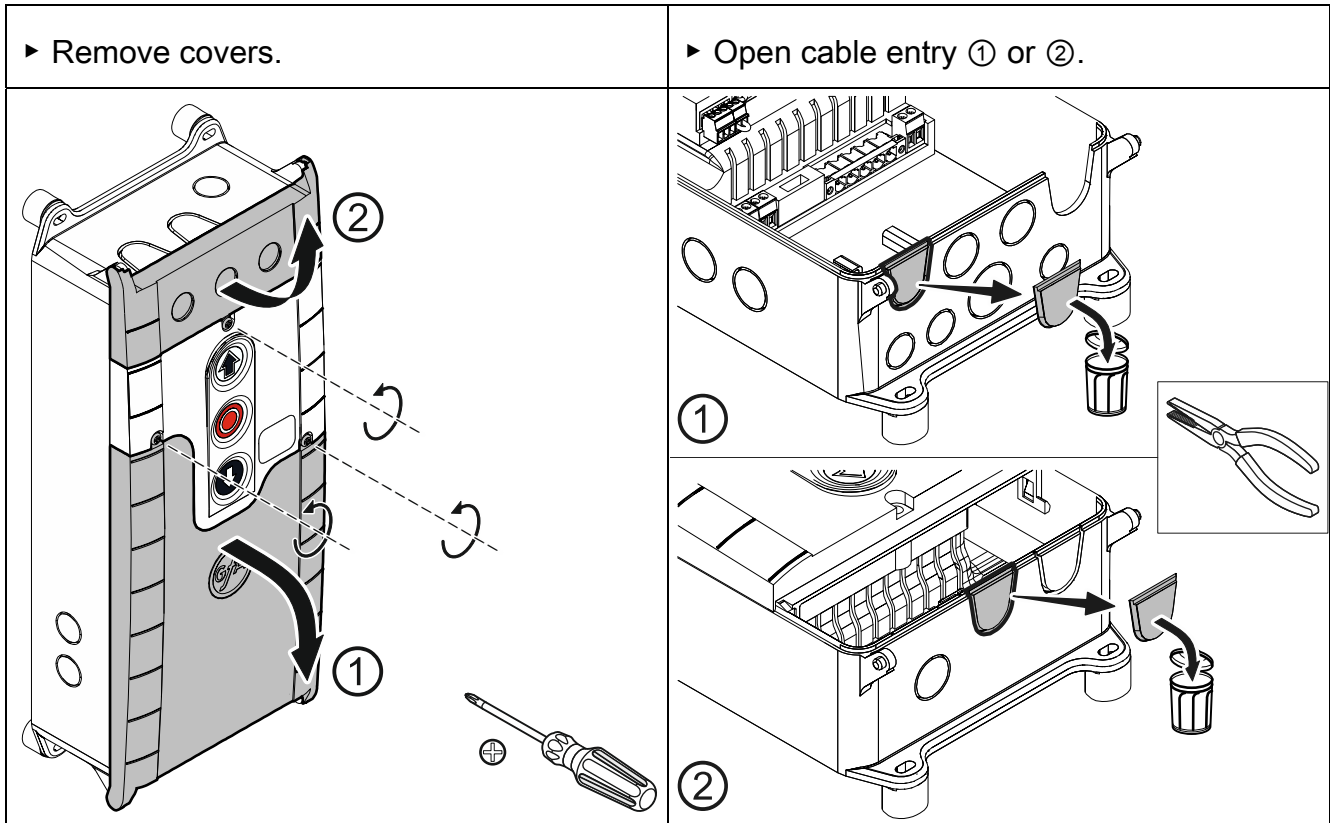

Avoid damage to parts!

- Open cable entry with suitable tool

Mains supply

<p>3~, N, PE 230 / 400 V 50 / 60 Hz</p> <p>L1 L2 L3 N PE</p>	<p>3~, PE 230 / 400 V 50 / 60 Hz</p> <p>L1 L2 L3 PE</p>	<p>1~, N, PE, sym. 230 V 50 / 60 Hz</p> <p>L N PE</p> <p>≠ SI 25.15 WS, SI 45.7 WS</p>	<p>1~, N, PE, asym. 230 V 50 / 60 Hz</p> <p>N L PE</p> <p>= SI 25.15 WS, SI 45.7 WS</p>
--	---	--	---

<p>3 x 400 V</p> <p>230V 1.7 1.6 1.5 20.3 20.2 20.1 1.8 1.9 400V</p>	<p>1 x 230 V / 3 x 230 V</p> <p>230V 1.7 1.6 1.5 20.3 20.2 20.1 1.8 1.9 400V</p>
--	--

Mains connection to control

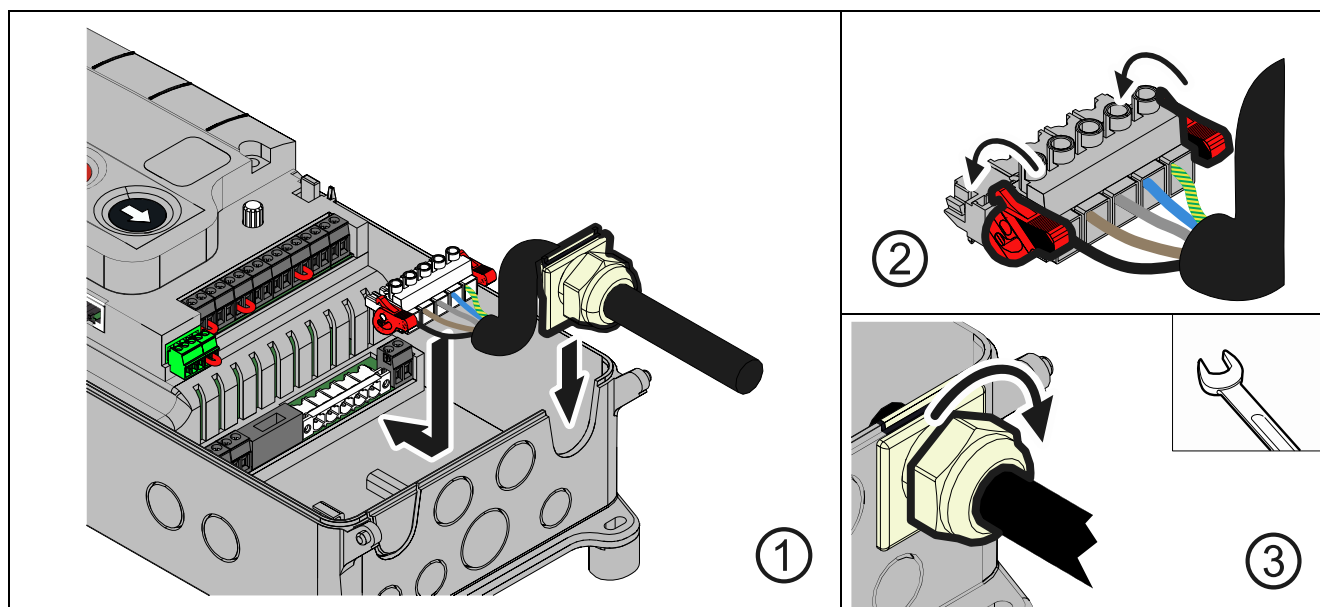

Completing the electrical installation

Install and tighten cable entries and/or cable glands.

For commissioning of the control, leave the covers open.

Overview of control

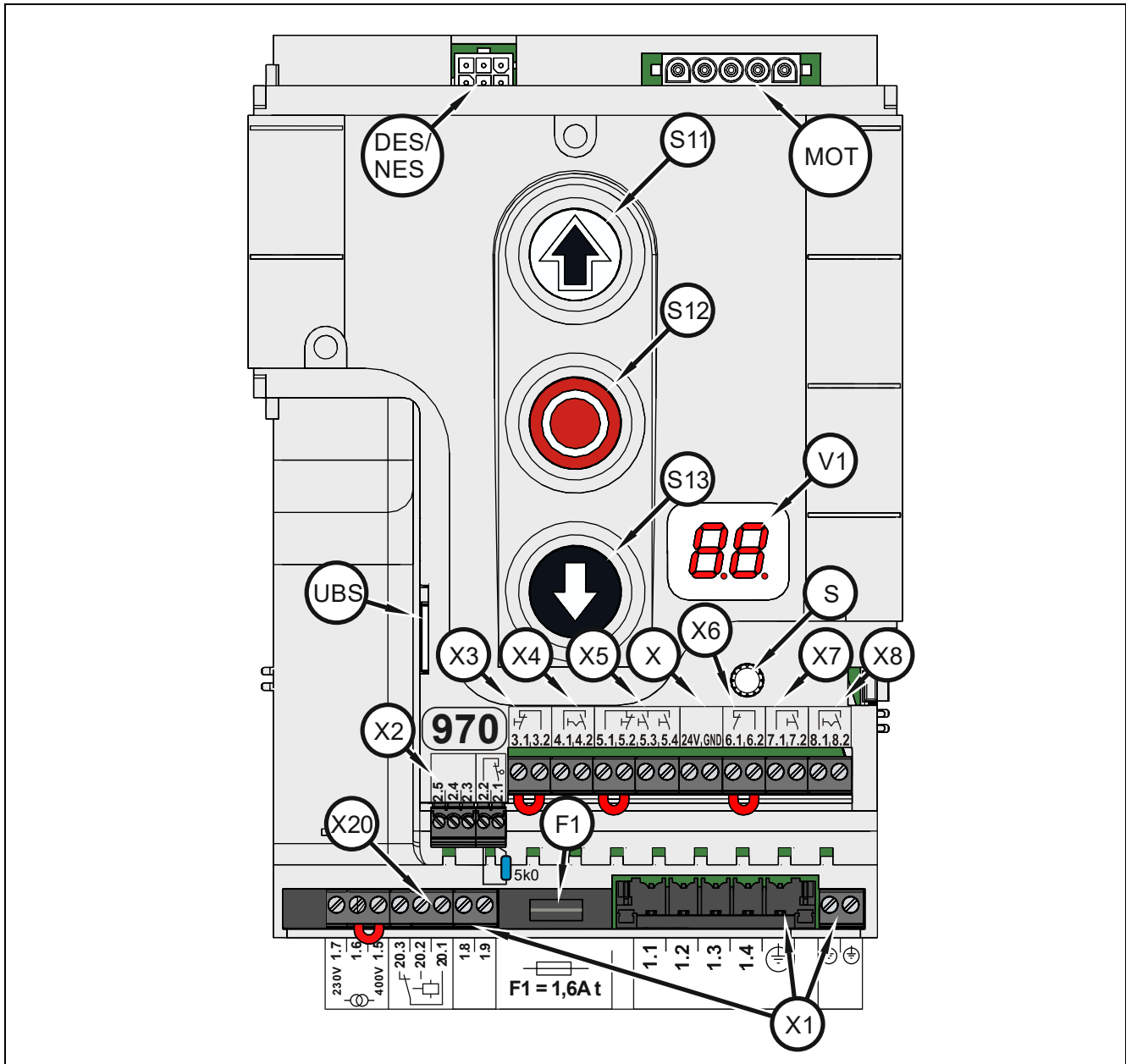

DES/ NES	DES or NES limit switch socket	X	24 V mains supply, external devices
		X1	Mains supply
F1	Micro-fuse 1.6 A time-lag	X2	Door safety switch and safety devices
MOT	Motor socket	X3	Emergency STOP control device
S	Selector switch	X4	Automatic closing On/Off
S11	OPEN push-button	X5	Control device, external three push-button
S12	STOP push-button	X6	Through / reflective photo cell
S13	CLOSE push-button	X7	Pull switch
UBS	Universal command sensor socket	X8	Intermediate stop On/Off
V1	Display	X20	Potential-free relay contact

5 Starting up the control

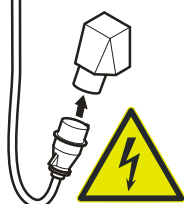
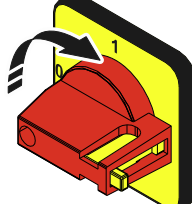
<p>► Supply cables Insert / switch on</p>		
---	--	---

DES: Rapid adjustment of final limit positions

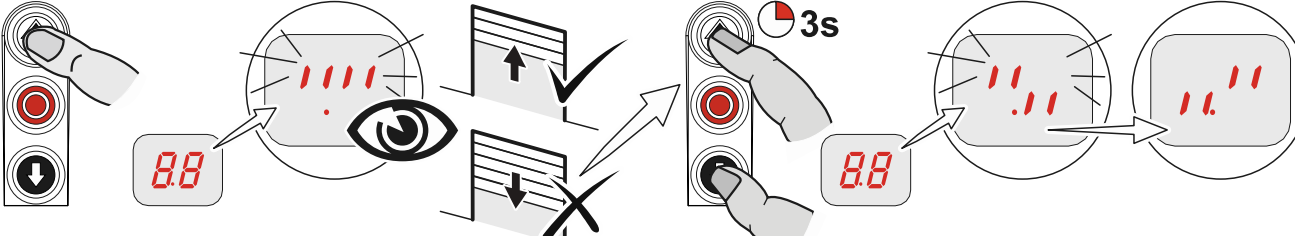
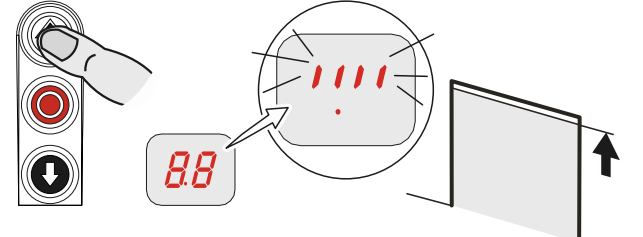
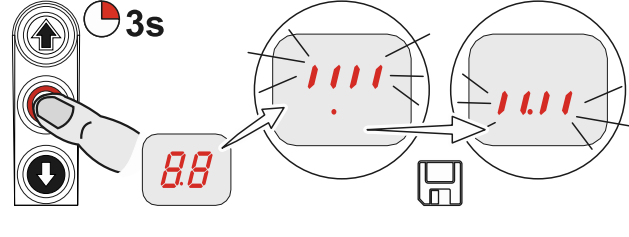
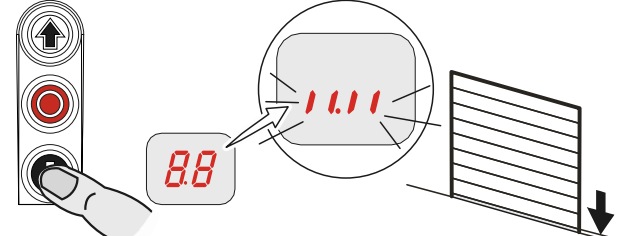
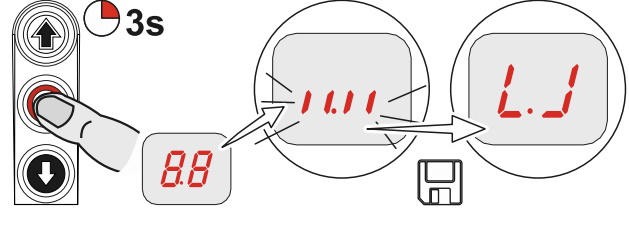
<p>1. Check output rotating direction</p>	
	
<p>2. Move to OPEN final limit position</p>	<p>3. Save OPEN final limit position</p>
	
<p>4. Move to CLOSE final limit position</p>	<p>5. Save CLOSE final limit position</p>
	



Note!

- The rapid adjustment is complete, "Hold-to-run" door operating mode is active
- Change of OPEN/CLOSE final limit positions via menu items "1.1" to "1.4"
- Pre-limit switch Safety edge is set automatically
- Changing the pre-limit position is possible via menu item "1.5"



Observe the installation instructions of the drive unit!

- For adjusting the mechanical limit switch, see the drive unit installation instructions

NES: Rapid adjustment of final limit positions

1. Check output rotating direction

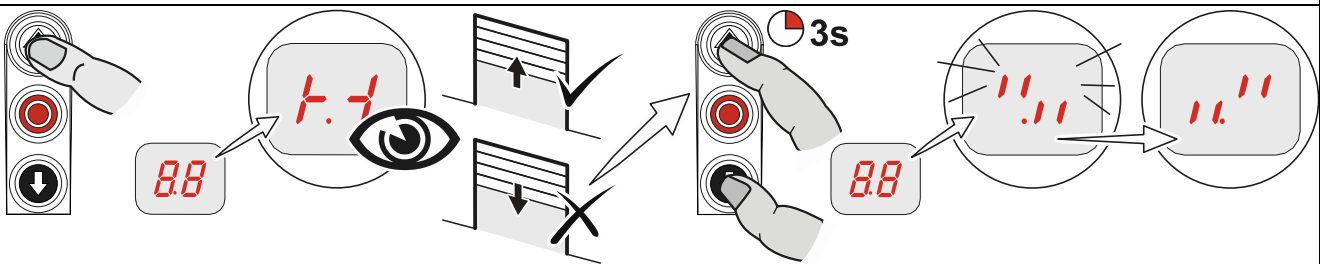

2. Move to OPEN final limit position and adjust S3 OPEN limit switch

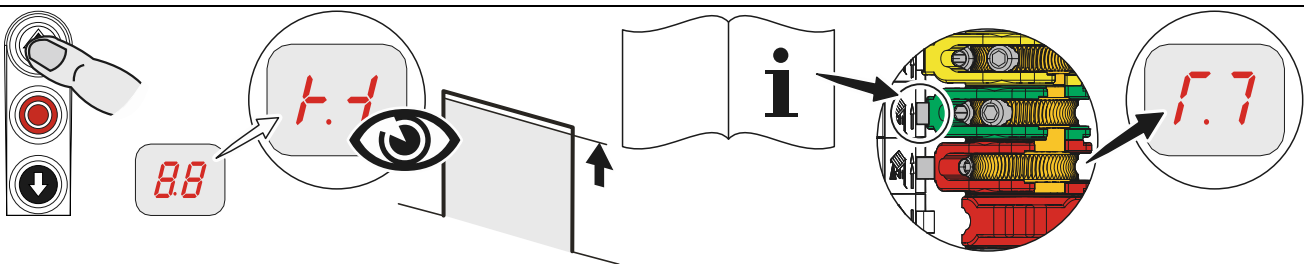

3. Move to CLOSE final limit position 5cm above the ground and adjust S5 pre-limit switch

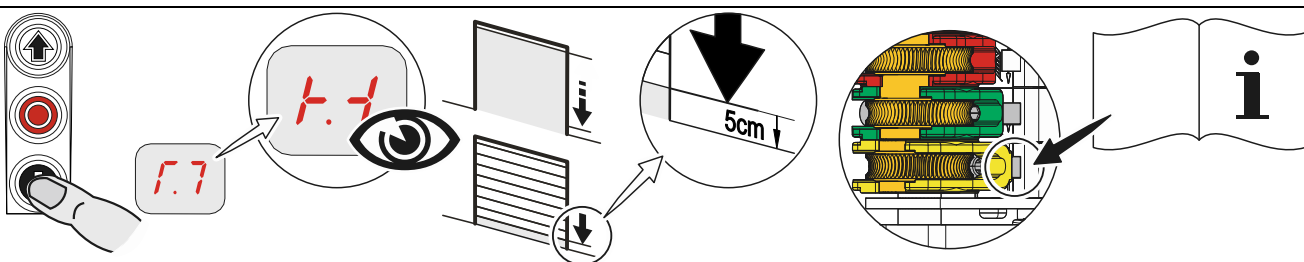

4. Move to CLOSE final limit position and adjust S4 CLOSE limit switch

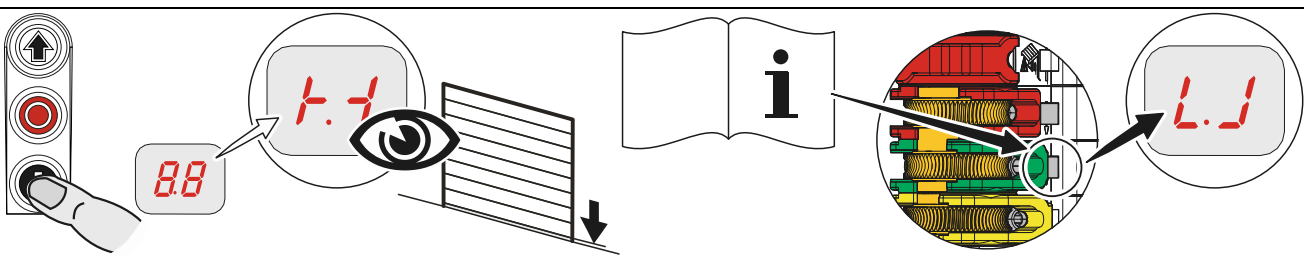

6 Electrical installation – control accessories

Connection of door safety switches X2

Pass-door switch / slack-rope switch
suitable for Performance Level c (PLc)

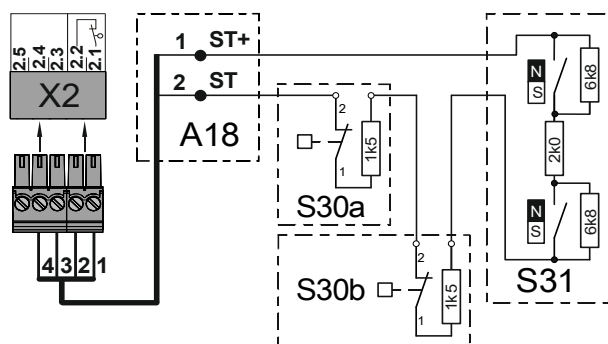

- A18** Junction box
- ST+** Mains supply
- ST** Input for door safety switch
- S30a** Pass-door switch
- S30b** (NC contact)
- S31** Electronic pass-door switch (Entrysense)

Crash switch as NC contact

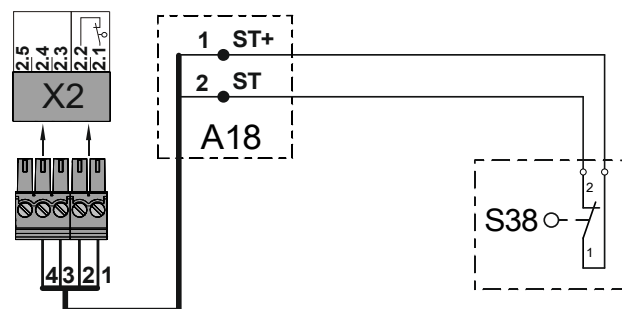

- A18** Junction box
- ST+** Mains supply
- ST** Input for door safety switch
- S38** Crash switch (NC contact)

Crash switch as NO contact

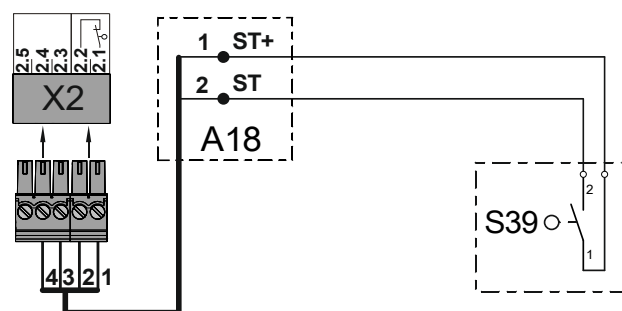

- A18** Junction box
- ST+** Mains supply
- ST** Input for door safety switch
- S39** Crash switch (NO contact)

Connection of safety devices X2

Electrical safety edge

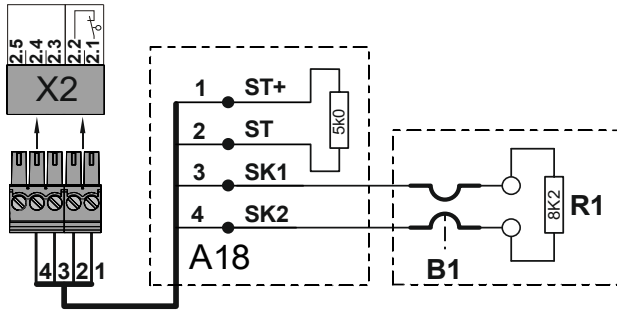

- A18** Junction box
- ST+** Mains supply
- ST** Input for door safety switch
- SK1** Input electrical safety edge
- SK2** Input electrical safety edge
- B1** Electrical safety edge
- R1** End of line resistor (8k2)
- X2** Door control socket

Pneumatic safety edge

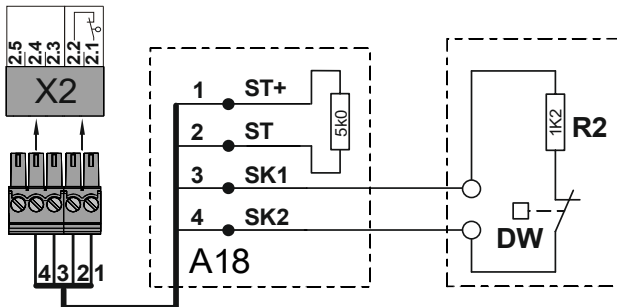

- A18** Junction box
- ST+** Mains supply
- ST** Input for door safety switch
- SK1** Input pneumatic safety edge
- SK2** Input pneumatic safety edge
- DW** Pneumatic switch
- R2** End of line resistor (1k2)
- X2** Door control socket

Optical safety edge

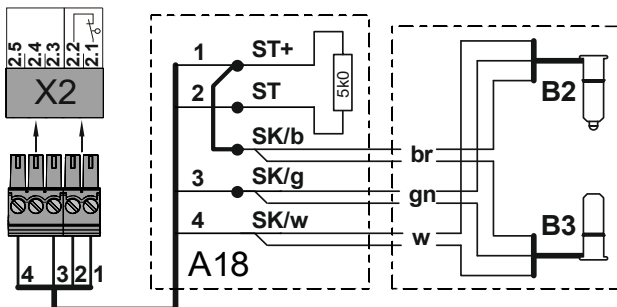

- A18** Junction box
- ST+** Mains supply
- ST** Input for door safety switch
- SK/b** Mains supply (brown)
- SK/g** Output (green)
- SK/w** Earth (white)
- B2** Optical transmitter
- B3** Optical receiver
- X2** Door control socket

External supply X1		Emergency STOP X3		Automatic closing, On/Off X4	
A1	External device	A2	Control device Emergency STOP	A3	Control device Key switch
F1	Micro-fuse 1,6 A				

External control device X5					
	Three push button	A4	Key push-button	A6	Three push button

Photo cell X6					
A8	Reflective photo cell	A9	Through-beam photo cell Transmitter	A11	Through-beam photo cell Transmitter
		A10	Receiver	A12	Receiver

Light curtain X6 (only with relay or semiconductor output)

X20	Function relay Test light curtain	A25	Light curtain Transmitter	A27	Light curtain Transmitter
		A26	Receiver	A28	Receiver

<h4>Radio receiver X7</h4>	<h4>Pull switch X7</h4>	<h4>Intermediate open X8</h4>
A13	A14	A15

<h4>Traffic light X20</h4>	<h4>Magnetic brake X20</h4>		
H1	Traffic-light	G1	Rectifier
		Y1	Magnetic brake



Note!

- Install and tighten cable entries and/or cable glands

7 Control programming

1. Start programming

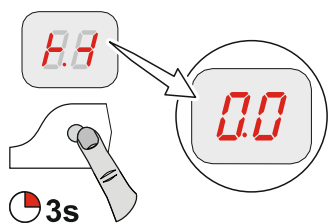

- ! Note!**
- Complete programming is only possible after setting the final limit positions.

2. Select menu item and confirm

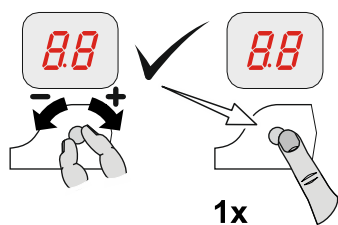

3.a) Set and save functions

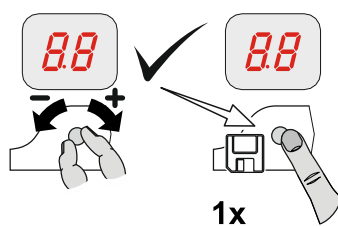



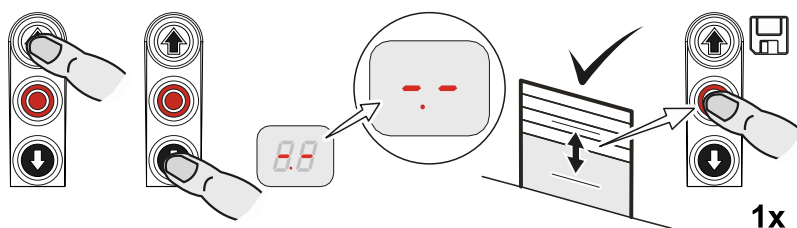



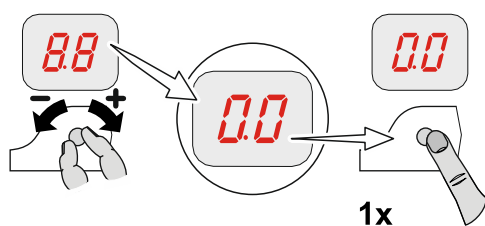













3.b) Set and save positions (DES)



4. Exit programming



















































8 Table menu items

Door operating modes			
		Door operating mode	
		Hold-to-run OPEN Hold-to-run CLOSE	 
		Self-hold OPEN Hold-to-run CLOSE	
		Self-hold OPEN Self-hold CLOSE	
		Self-hold OPEN / CLOSE Self-hold, CLOSE hold-to-run release via external X5 control device	
		Hold-to-run OPEN Hold-to-run CLOSE with active safety edge	
		Output rotating direction	
 		Maintain output rotating direction	 
		Change output rotating direction	

Door positions					
	1x	OPEN final limit position, coarse correction (DES)			
			Approach and store desired door position		1x
	1x	CLOSE final limit position, coarse correction (DES)			
			Approach and store desired door position		1x
	1x	OPEN final limit position, fine correction (DES)			
				Without door movement, [+] OPEN correction [-] CLOSE correction	1x
	1x	CLOSE final limit position, fine correction (DES)			
				Without door movement, [+] OPEN correction [-] CLOSE correction	1x
	1x	Fine-correction pre-limit switch for safety edge (DES)			
				Without door movement, [+] OPEN correction [-] CLOSE correction	1x
	1x	Adjust intermediate open X8 (DES)*			
			Approach and store desired door position		1x
	1x	Setting for position of relay switching point (DES)* Select relay function via menu item 2.7			
			Approach and store desired door position		1x

*) Menu items 1.6 to 1.7 disappear at NES. The switching point must be adjusted via the S6 auxiliary limit switch at the drive unit.

Door functions				
	Safety edge function in the pre-limit area			
		Safety edge active		
		Safety edge inactive		
		Ground adjustment (DES) (Activation of safety edge at ground contact)		
		Reversing in upwards direction in overrun area (DES)		
	Overrun correction (DES)			
		Off		
		On (Do not use with ground adjustment)		

Door functions								
23	 1x	Automatic closing						
	 .0	Off			 1x			
	 .1		 9.9	1 to 99 seconds				
	 1-		 0.0				 9.9	100 to 199 seconds
	 2-		 0.0				 4.0	200 to 240 seconds
24	 1x	Reaction of automatic closing to photo cell / light curtain						
	 .0	Off			 1x			
	 .1	Stopping of automatic closing and CLOSE command						
	 .2	Vessel recognition Stopping of automatic closing and CLOSE command when actuated for >1.5 seconds						
25	 1x	Reverse in case of obstacle						
	 .0	Off			 1x			
	 .1		 1.0	Adjustable from 1 to 10 Number of safety device actuations				
26	 1x	Pull switch or radio receiver X7						
	 .1	Type of impuls 1 Door is in OPEN final limit position CLOSE command Door is not at OPEN final limit position OPEN command			 1x			
	 .2	Pulse type 2 Command sequence OPEN – STOP – CLOSE – STOP – OPEN						
	 .3	Type of impuls 3 OPEN command only						







































































Door functions



















2.7 1x		Relay function on X20	
	.0	Off	1x
	.1	Impulscontact* for 1 second	
	.2	Permanent contact*	
	.3	Red lamp, permanently lit during door movement OPEN final limit position Flashing for 3 seconds CLOSE final limit position Flashing for 3 seconds	
	.4	Red lamp, permanently lit during door movement OPEN final limit position Flashing for 3 seconds CLOSE final limit position Off	
	.5	Red lamp, permanently lit during door movement OPEN final limit position Permanently lit for 3 seconds CLOSE final limit position Permanently lit for 3 seconds	
	.6	Red lamp, permanently lit during door movement OPEN final limit position Permanently lit for 3 seconds CLOSE final limit position Off	
	.7	Permanent green light Dock leveller release Active only in OPEN final limit position	
	.8	Permanent contact in CLOSE final limit position	
	.10	Light sensing device 1-second pulse at each OPEN command	
	.11	Permanent contact at door position*	
	.12	Brake control Active during operation Inactive at stop	
.14	Light curtain test, etc. Test prior to each closing operation		

*) Previous teach-in of door positions via menu item 1.7 Relais X20 (only DES) or respectively via the S6 auxiliary limit switch of the drive unit (NES).

Door functions					
		Intermediate open function			
		All command inputs			
		Input X7.2			
		Input X5.3 and OPEN push-button of control			

Safety functions						
		Force monitoring (DES)				
					0 = Off Adjustable for 2 % to 10 % overload	
		Interruption of the photo cell function (DES)				
		Off			 	
		On (single reference position taught-in twice)				
		Travel time monitoring (NES)				
				0 = Off 0 to 90 seconds		
		Door safety switch (Input X2.2)				
		Slack-rope switch / Pass-door switch			 	
		Crash switch as NC contact After activation changeover to "Hold-to-run" door operating mode				
		Crash switch as NO contact After activation changeover to "Hold-to-run" door operating mode				
		Reversing duration adjustment				
				[+] slower [-] faster		

DI/FI settings				
4.1	 1x	OPEN output speed		
 - +	 00	  	Output speed in rpm	 1x
4.2	 1x	CLOSE output speed When a safety device is triggered, the door moves at reduced speed.		
 - +	 00	  	Output speed in rpm	 1x
4.3	 1x	Increased CLOSE output speed Up to an opening height of 2.5 m When a safety device is triggered, the door moves at reduced speed.		
 - +	 00	  	Output speed in rpm 0 = Off	 1x
4.4	 1x	Changeover position to CLOSE output speed (with adherence to minimum opening height requirement of 2.5 m!)		
		Approach and store desired door position		 1x
4.5	 1x	OPEN acceleration		
 - +	 00	  	DI Steps of 1.0 seconds FI Steps of 0.1 seconds	 1x
4.6	 1x	CLOSE acceleration		
 - +	 00	  	DI Steps of 1.0 seconds FI Steps of 0.1 seconds	 1x
4.7	 1x	OPEN deceleration		
 - +	 00	  	DI Steps of 1.0 seconds FI Steps of 0.1 seconds	 1x
4.8	 1x	CLOSE deceleration		
 - +	 00	  	DI Steps of 1.0 seconds FI Steps of 0.1 seconds	 1x
4.9	 1x	OPEN/CLOSE crawling speed		
 - +	 00	  	Output speed in rpm	 1x

Maintenance cycle counter				
 1x	Maintenance cycle preselection			  
 				01-99 corresponds to 1000-99000 cycles cycles are counted down 
 1x	Reaction upon reaching "0"			
		Status indication "CS" appears in turns with value set by menu item 8.5 .		 
		Changeover to "hold-to-run" door operating mode. Status indication "CS" appears in turns with value set by menu item 8.5 .		
		Changeover to "hold-to-run" door operating mode. Status indication "CS" appears in turns with value set by menu item 8.5 . Option: Press STOP-button for 3 seconds to deactivate changeover and status indications for 500 cycles.		
		Status indication "CS" appears in turns with value set by menu item 8.5 and relay contact X20 switches.		

Readout of Data memory			
		Cycle counter 7-digit number	
	M HT ZT T H Z E	Displayed in division of ten consecutively M = 1,000,000 ZT = 10,000 H = 100 E = 1 HT = 100,000 T = 1,000 Z = 10	
		Last faults	
	Display change of the last 6 faults		
		Data counter 7-digit number	
	M HT ZT T H Z E	Displayed in division of ten consecutively M = 1,000,000 ZT = 10,000 H = 100 E = 1 HT = 100,000 T = 1,000 Z = 10	
	Cycle counter of the last change in programming Number of activations of slack-rope, pass-door and crash switch		 1x
		Software version	
	The firmware version of the control is displayed. Additionally the software version of the motor is displayed for DI-drives and FI-drives.		

Deleting / Readout			
		Deleting of all settings	
	Activating GfA stick All settings are set to factory setting! Except for cycle counter		 1x 3s

9 Safety devices

X2: Input, door safety switch

The door safety switch is installed on the door and connected to the door control via the spiral cable.

Menu item 3.4:

Function	Reaction upon activation
„1“ Slack-rope switch / pass-door switch	<ul style="list-style-type: none"> • Switching contact is interrupted: Door stop • Switching contact is closed: Door is ready for operation
„2“ Crash switch as NC contact	<ul style="list-style-type: none"> • Door stops • Changeover to "Hold-to-run" door operating mode • Frequency inverter: "Hold-to-run" door operating mode at crawling speed only • Fault reset only possible in OPEN final limit position: Press the STOP-button of the door control for 3 seconds
„3“ Crash switch as NO contact	Like function „2“

Door safety switch

The door safety switches (slack-rope switch / pass-door switch) are connected to a safety circuit with Performance Level c (Plc) according to ISO 13849-1 (X2.1/X2.2). Accordingly, only switches with the same Performance Level c (Plc) may be connected. The safety circuit requires an overall terminal resistance of 5k Ω for line cross-circuit monitoring. When the door safety switch is activated, it is not possible to move the door. When activated during door movement, an immediate STOP takes place. Fault indication F1.2 will be displayed.

Slack-rope switch

The evaluation of the door control provides for the connection of two slack-rope switches. For line cross-circuit monitoring, a resistor of 1k5 must be integrated in the switches. In the case of a line cross-circuit, fault indication F1.8 is displayed.

Electronic pass-door switch (Entrysense)

The electronic pass-door switch (Entrysense) has a Performance Level c (Plc) according to ISO 13849-1 and is monitored by the door control. Any other switch used must have Performance Level c (Plc) according to ISO 13849-1.

For line cross-circuit monitoring, a resistor of 2k0 must be integrated in the switch. In the case of switch failure, fault indication F1.7 is displayed. In the case of a line cross-circuit, fault indication F1.8 is displayed.

Crash switch as NC or NO contact

The crash switch is activated if the door is pushed out of the guides.

If the switching contact is activated, the door is stopped, fault indication F4.5 is displayed, and a changeover to "Hold-to-run" door operating mode is carried out. The door can be moved only via the built in push button of the door control. "Hold-to-run" door operating mode for frequency inverter only at crawling speed.

The fault indication F4.5 can only be reset in OPEN final limit position by pressing the STOP-button of the door control for more than 3 seconds or by switching the mains voltage off and on. Fault F4.5 will recur, if the switching contact continues to be activated.

X2: Input for safety devices

The door control automatically detects three different safety edges to protect the closing movement of the gate wing.



Important!

- Connect safety edges in accordance with EN 12978
- "Hold-to-run" door operating mode can always be used should the safety edge be defective

Electrical safety edge

The input is meant for an electrical safety edge (NO) with a terminal resistance of 8k2 (+/-5 % and 0,25 W).

If there is a short circuit, fault indication F2.4 is displayed. If there is an open circuit, the F2.5 fault indication appears.

Pneumatic safety edge

The input is meant for a pressure wave switch system (NC) with a terminal resistance of 1k2 (+/-5 % and 0,25 W).

Upon activation or permanent disconnection of the current circuit, the F2.6 fault indication appears.

If there is a short circuit, fault indication F2.7 is displayed.

The pressure wave switch system needs to be tested with CLOSE final limit position. The test phase is initiated by the pre-limit switch (automatically for DES). If no switching signal is generated on the pressure wave switch within 2 seconds, the test is negative and the fault indication F2.8 is displayed.

Optical safety edge system

The input is meant for an infrared safety beam sensor with transmitter and receiver in a rubber profile. By pressing the rubber profile, the light beam is interrupted.

The F2.9 fault indication appears upon activation or a faulty safety edge system

Installation of the spiral cable

The spiral cable should enter the door control panel from the left- or right-hand side. The spiral cable should be fixed in place with a cable gland. The safety edge system is connected via the 3-pole plug, and the slack-rope or the pass door via the 2-pole plug.



Important!

- ▶ Check position of S5 pre-limit switch on the safety edge (only for NES)
- When the door is opened > 5cm, a reversing must be executed if the safety edge has been activated

Function: Safety edge function in the pre-limit area

Menu item 2.1:

Function	Reaction to activation of safety edge
„.1“ Active	<ul style="list-style-type: none"> • Door stops
„.2“ Inactive	<ul style="list-style-type: none"> • No reaction • Door moves to CLOSE final limit position
„.3“ Ground adjustment (DES)	<ul style="list-style-type: none"> • Door stops; correction of the CLOSE final limit position at the next closing
„.4“ Reversing in overrun area (DES)	<ul style="list-style-type: none"> • Reversing upwards from the overrun area upon activation of the safety edge system



Note: Ground adjustment!

- Automatic compensation of rope elongations or changes in ground conditions of approx. 2-5 cm
- With DES limit switch only
- Do not use with overrun correction
- Do not use with pneumatic switch



Note: Reversing upwards in the overrun area!

- To maintain the operating forces in the pre-limit area
- At high speeds
- With DES limit switch only
- Function for FI-drive units not necessary

Function: Overrun correction function (only DES)

Menu item 2.2:

Automatic limit switch correction to achieve a constant CLOSE position.

Function	Overrun correction
„0“	Off
„1“	On



Note: Overrun correction!

- With DES limit switch only
- Do not use with ground adjustment

Function: Reverse in case of obstacle

Menu item 2.5 extends menu item 2.3:

Menu item 2.3 (automatic closing) allows the door to close automatically after a pre-set time has elapsed. If an obstacle is in the door movement path during the closing process (safety device is triggered), the door stops the closing attempt and then moves back to its starting position.

With menu item 2.5 (reversing in case of obstacle) you can set the number of closing attempts. For example, if the factory setting is „2“, the door will try to close twice and then stop in the upper start position if there is an obstacle. Fault indication F2.2 then appears in the menu.



Note!

- To reset fault F2.2: Move to CLOSE final limit position

EMERGENCY operation



Warning!

- ▶ For EMERGENCY operation, the door has to be checked (it has to be in a fault-free state)
 - “Hold-to-run” door operating mode:
 - The door must be fully visible from the operating point

EMERGENCY operation allows for moving the door to a required position by bypassing faults with the signal transmission of the safety device.



EMERGENCY operation is activated after pressing the STOP push-button and holding for 7 seconds, and is indicated by the flashing display.



Note!

- The door cannot be moved in case of F1.3 and F1.4 fault indications for reasons of operating safety.
 - ▶ Activation of EMERGENCY operation: Use the built in push button of the control to press and hold the STOP-button while simultaneously pressing the OPEN or CLOSE push-button to move the door

X3: Input, emergency STOP

The emergency STOP control device is connected to a safety circuit with Performance Level c (Plc) according to ISO 13849-1. Connection of an emergency STOP control device as per EN 13850 or an evaluation unit for an anti-trap safety device. The F1.4 fault indication appears upon activation.



Note!

- Frequency inverter drive unit: The emergency STOP switches the supply off. The door control can only be operated again 30 seconds after unlocking the emergency STOP. (Display rotates during this time)





10 Functional description

X: 24 VDC voltage supply

Connection of external devices such as photo cell, radio receiver, relay, etc. via the 24 V and GND terminals.



Attention – Damage to components!

- Total current consumption of external devices: maximum 180 mA

X1: Mains supply of the control and supply of external devices

Mains supply of the control

Connection via the terminals X1/1.1 to X1/1.4 and PE.

Various mains connections: 3 N~, 3~, 1 N~ for symmetric and asymmetric motors.

Power supply 400 V = Wire link 1.5 – 1.6

Power supply 230 V = Wire link 1.6 – 1.7



Note!

- ▶ Pay attention to the "Mains supply connection" and "Mains supply connection to control" descriptions

Supply of external devices

Connection of external devices for 230 V, such as photo cell, radio receiver, relay, etc. via terminals X1/1.8 and X1/1.9.



Note!

- The mains supply of external devices using terminals X1 / 1.8 and X1 / 1.9 is only possible if the door control is connected to supply networks with 3 N ~ 400 V or 1 N ~ 230 V (symmetrical)
 - Protection via F1, 1.6-A time-lag micro-fuse

X4: Input, automatic closing Off/On

Connection of a switch via the terminals X4/1 and X4/2 for switching the automatic closing off and on.

X5: Input, control device



Warning!

▶ "Hold-to-run" door operating mode:

The door must be fully visible from the operating point

The door operating mode „3“ allows a place of installation of the control device without sight of the door.



Note!

- ▶ Application without STOP push-button: Connect wire link X5.1 to wire link X5.2
- If the safety edge or photo cell fails, the control device will not function

X6: Input „Through / reflective photo cell“ resp. light curtain

Photo cell

A photo cell is used for presence detection. It is only active in door operating modes „3“ and „4“, in the OPEN final limit position or during the CLOSE-operation.

If the light beam is interrupted, fault indication F2.1 appears.

Light curtain

The light curtain must be self-testing and correspond at least to safety category 2 or performance level c (plc). If the light curtain corresponds to these requirements, the door can close into self-hold without safety edge system.



Important!

- ▶ Operation without safety edge: Connect resistor 8k2 via the terminals X2/3 and X2/4
- ▶ Photo cells must not be used via the UBS system if a light curtain is used
- ▶ Do not use menu item 3.2 for the light curtain

- ▶ To test the light curtain, activate relay contact X20.

The relay functions are described under menu item 2.7 / 2.8.

If the light beam is interrupted, fault indication F4.6 appears.

A testing is carried out with every CLOSE-command. Thereby the contact of the light curtain must switch off within 100 ms. If the test is positive, the contact must switch back on within 300 ms. If the test is negative, the fault indication F4.7 is displayed.

- ▶ To reset fault indication F4.7: Switch control off and on.



Note!

- ▶ Only use photo cells or light curtains with "Light switching" mode

Reaction to interrupting of light beam

Door position	Reaction to interrupting of light beam
CLOSE final limit position	<ul style="list-style-type: none"> No action
OPEN-operation	<ul style="list-style-type: none"> No action
OPEN final limit position Without automatic closing	<ul style="list-style-type: none"> No action
OPEN final limit position With automatic closing	<ul style="list-style-type: none"> Reset automatic closing
OPEN final limit position With automatic closing and interruption to timer	<ul style="list-style-type: none"> The door closes 3 seconds after the interruption period for the light beam has ended

Reaction of automatic closing to photo cell / light curtain

Menu item 2.4:

Function	Reaction of automatic closing to photo cell / light curtain
„.0“	<ul style="list-style-type: none"> No action
„.1“ Stopping automatic closing	<ul style="list-style-type: none"> The door closes 3 seconds after the interruption period for the light beam has ended
„.2“ Vessel recognition	<ul style="list-style-type: none"> The door closes after the interruption period for the light beam has ended, if the interruption period is longer than 1.5 seconds Reset of automatic closing if the interruption duration for the light beam is equal to or less than 1.5 seconds

Disconnection of photo cell function (only DES)

Menu item 3.2:

Function	Disconnection of photo cell function
„0“	Off
„1“	On



The teach-in mode gets activated after exiting the programming.



Warning!

- Presence detection is disabled in the teach-in mode

In the teach-in mode, the door must be fully opened and closed twice. The light beam must be interrupted twice at the same door position. The teach-in mode is then terminated. The photo cell has no function below this stored door position.

Teach-in mode display	
Upon exiting the program	
When the light beam is interrupted for the first time	
After the second interruption to the light beam at the same door position, and with the CLOSE final limit position reached	



Note!

- If the teaching-in is not successful, open and close the door again, so that two identical door positions are stored

X7: Input pull switch/radio receiver

Connection of a pull switch or external radio receiver via the terminals X7/1 and X7/2. The switching contact must be potential-free (NO contact).

Pull switch or radio receiver function

Menu item 2.6:

Pulse type	Reaction upon activation
„1“	<ul style="list-style-type: none">• Door is in OPEN final limit position or respectively in intermediate open position: The door CLOSES• From all other door positions or door movements: The door OPENS
„2“	<ul style="list-style-type: none">• OPEN-STOP-CLOSE-STOP-OPEN command order
„3“	<ul style="list-style-type: none">• Door always executes OPEN movement

X8: Input, intermediate stop On/Off

Connect a switch to terminals X8/1 and X8/2 to activate and deactivate the intermediate open. The intermediate open position muss be programmed via menu item **1.6**.

With an OPEN command, the door moves to the stored door position. When the Intermediate open function is deactivated, the door can move back to the OPEN final limit position.

intermediate open function

Menu item 2.9:

Function	Intermediate open
„1“	<ul style="list-style-type: none"> • All command inputs
„2“	<ul style="list-style-type: none"> • Intermediate open via X7 pull switch • OPEN final limit position via all other control devices
„3“	<ul style="list-style-type: none"> • Intermediate open via external control devices X5 and OPEN push button of the control • OPEN final limit position via all other control devices



Note!

- Double command with functions „2" and „3": Priority is given to OPEN final limit position, independent of command sequence

Potential-free X20 relay contact

The relay functions are described under menu item 2.7.



Attention – Damage to components!

- Maximum current of 1 A at 230 V AC and 0.4 A at 24 V DC
- We recommend the use of LED lamps
- When using light bulbs, these should have power of maximum 40 W and be shock-proof

Force monitoring (DES only)

Menu item 3.1:

The force monitoring can only be used with fully balanced doors and drive units with DES. It should be able to detect when persons are moving with the door.



Warning!

- The force monitoring is no substitute for safety measures in providing protection against the trapping hazard

Function	Force monitoring
„0“	<ul style="list-style-type: none"> • Off
„.2“ - „1.0“	<ul style="list-style-type: none"> • „.2“: Low limit value • „1.0“: High limit value



Important!

- Force monitoring for doors with spring balance only
- Environmental factors such as changes in temperature or wind load can lead to inadvertent triggering of force monitoring

After exiting programming, the door must carry out a full OPEN and CLOSE-operation in self-hold mode.

The force monitoring is a self-learning system which is effective for an opening width range of 5 cm to 2 m (approx.). Slow progressive changes, e.g. gradual reduction of the spring torsion, are compensated automatically.

After force monitoring has been triggered, only the "Hold-to-run" door operating mode is possible and the F4.1 fault indication is displayed. The resetting occurs when a final limit position for the door is reached.

Travel time monitoring (NES only)

Menu item 3.3:

The set travel time is automatically compared with the time measured for movement between the final limit positions. If the travel time is exceeded, the F5.6 fault indication appears.

Fault indication F5.6 is reset by closing the door.



Note!

- The travel time is set at the factory to 90 seconds
- Recommended setting value: door travel time + 7 seconds

UBS system

The UBS system is a simple pluggable connection technology from GfA. The control devices are connected to the control by a commercially available patch cable and detected automatically.



Note!

- The UBS devices function in the same way as wired control devices

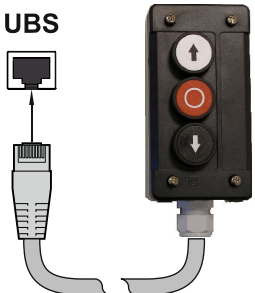
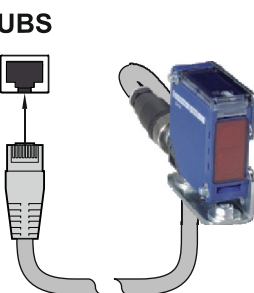
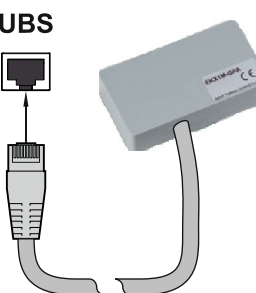
UBS connection		
 <p>UBS</p>	 <p>UBS</p>	 <p>UBS</p>
<p>Three push button</p>	<p>Reflective photo cell</p>	<p>External radio receiver</p>

Reversing duration adjustment

Menu item **3.8**:

Shortening the reversing duration serves for a reduction of the operating forces.

Extending it, on the other hand, will reduce the wear on the door mechanism.

Maintenance cycle counter

Menu item **8.5**:

A value between 0 and 99,000, as a multiple of 1000, can be selected for the maintenance cycle setting. The maintenance cycle counter reading is reduced by one each time the Open final limit position is reached.

Once the maintenance cycle reaches zero, the setting from menu item **8.6** is activated.

Short-circuit/overload display

If there is a short circuit or an overload of the 24 VDC supply voltage, the 7-digit display vanishes.

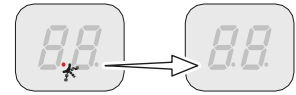









Standby function











If there is no fault or command pending, the control switches to Standby.











If the automatic closing duration is longer than 60 seconds, the control also switches to Standby. Only the left dot is lit up. The Standby function is terminated with a command or by activation of the selector switch **S**.





















11 Status display





Faults		
	Display: "F" and digit	
Code	Fault description	Fault causes and fault correction
	Terminals X2.1 – X2.2 are open. Slack-rope switch/Pass-door contact is open.	Check door safety switch. Check whether the connection cable is connected.
	Open safety circuit (DES) Emergency manual operation has been activated. Thermal protection of the motor has tripped.	Check emergency manual operation. Check door and door drive unit for stalling. Warning! Danger of the door dropping! Stalling may indicate the anti fall back device (if incorporated) has activated. Take appropriate measures.
	Terminals X3.1 – X3.2 are open. Emergency STOP has been activated.	Check emergency STOP. Check whether the connection cable is connected.
	Faulty entrysense switch. Faulty entrysense installation.	Open and close pass door. Check the DIP-switch in the junction box for spiral cable. Check the resistance and wiring of the spiral cable. Check the pass door installation.
	Line cross-circuit in the safety circuit.	Switch control off and on. Check the DIP-switch in the junction box for spiral cable. Check the resistance and wiring of the spiral cable.
	No safety edge detected.	Check the wiring of the safety edge.
	Terminals X6.1 – X6.2 are open. Photo cell has been activated.	Check alignment of the photo cell. Check connection cable. Replace photo cell if necessary.
	Maximum number of reversing for door through safety edge system activation has been reached. (Only with automatic closing)	Obstacles along the door travel path. Check whether the safety edge is correctly functioning.

















Faults		
	Display: "F" and digit	
Code	Fault description	Fault causes and fault correction
	Activation of safety edge 8k2.	Check whether the safety edge is correctly functioning. Check whether the connection cable has a short circuit.
	Safety edge 8k2 defective.	Check whether the safety edge is correctly functioning. Check whether the connection cable is connected.
	Activation of safety edge 1k2.	Check whether the safety edge is correctly functioning. Check whether the connection cable is connected.
	Safety edge 1k2 defective.	Check whether the safety edge is correctly functioning. Check whether the connection cable has a short circuit.
	1k2 testing is negative.	Testing is activated in the lower final limit position. Check pre-limit switch (with NES "S5").
	Optical safety edge system has been activated or is defective.	Check whether the safety edge is correctly functioning.
	(DES) OPEN emergency limit switch reached.	In the voltage-free state, move the door back via emergency manual operation.
	(NES) OPEN or CLOSE emergency limit switch reached. Emergency manual operation has been activated. Thermal protection of the motor has tripped Limit switch system has changed over from NES to DES without the control being reset.	Check OPEN/CLOSE emergency stop switch. Check emergency manual operation. Reset of control via menu item "9.5". Check door and door drive unit for stalling. Warning! Danger of the door dropping! Stalling may indicate the anti fall back device (if incorporated) has activated. Take appropriate measures.
	(DES) CLOSE emergency stop switch reached.	In the voltage-free state, move the door back via emergency manual operation.
	(NES) Faulty activation of the "S5" pre-limit switch.	Check the "S5" pre-limit switch for correct functioning and setting.

Faults		
	Display: "F" and digit	
Code	Fault description	Fault causes and fault correction
	No limit switch detected (active at initial operation).	Connect the limit switch to the control. Check the limit-switch connection cable.
	Limit switch system has changed over from DES to NES without the control being reset.	Reset of control via menu item "9.5".
	Internal plausibility error.	Execute fault clearance through movement command.
	Triggering of force monitoring.	Check the door mechanism for stiffness.
	Crash switch X2.1 – X2.2 is activated.	Check crash switch / connection cable. To reset fault: Press STOP-button and hold for 3 seconds.
	Terminals X6.1 – X6.2 are open. Light curtain has been activated.	Check light curtain. Check whether the connection cable is connected.
	Light curtain defective.	Comply with the light curtain manufacturer's specifications. Check connection cable.
	Fault of the controller.	Switch control off and on. Replace control if necessary.
	ROM error.	Switch control off and on. Replace control if necessary.
	CPU error.	Switch control off and on. Replace control if necessary.













Faults		
	Display: "F" and digit	
Code	Fault description	Fault causes and fault correction
	RAM error.	Switch control off and on. Replace control if necessary.
	Internal fault of control.	Switch control off and on. Replace control if necessary.
	Fault of digital limit switch (DES).	Check DES connector and connection cable. Switch control off and on.
	Fault with door movement.	Check the limit switch turn. Switch control off and on. Check door and door drive unit for stalling. Warning! Danger of the door dropping! Stalling may indicate the anti fall back device (if incorporated) has activated. Take appropriate measures.
	Fault with rotating direction.	Change rotating direction via menu item "0.2".
	Unacceptable door movement in stopped state.	Execute fault clearance trough movement command. Check brake and drive unit.
	No compliance with open direction at drive unit.	Execute fault clearance trough movement command. Check for overload of the drive.
	DI / FI closing speed is too high.	Switch control off and on. Replace drive unit if necessary.
	Internal FI communication fault.	Switch control off and on. Replace FI-drive unit if necessary.
	Low voltage in the DC voltage sink.	Execute fault clearance trough movement command. Check mains input voltage. Change slope times/speed.









Faults		
	Display: "F" and digit	
Code	Fault description	Fault causes and fault correction
	Excess voltage in the DC voltage link.	Check mains input voltage. Execute fault clearance trough movement command. Change slope times/speed.
	Temperature limit exceeded.	Check for overload of the drive unit. Cool down the drive unit and reduce the number of cycles.
	Permanent current overload.	Check for overload of the drive unit. Check the door mechanism for stiffness or weight.
	Brake / FI fault.	Check brake; replace if necessary. If problem recurs, replace drive unit.
	Collective indication for FI.	Execute fault clearance trough movement command. Replace drive unit if message continues to be displayed.
	At initial operation minimum travel distance was not completed.	Move the door for at least 1 second.

Commands	
	Display: "E" and code
Code	Command description
	An Open command is present. Inputs X5.3, X7.2, UBS control device or UBS radio receiver.
	A STOP command is present. Inputs X5.2, X7.2, UBS control device or UBS radio receiver or simultaneous Open and Close command.
	A CLOSE command is present. Inputs X5.4, X7.2, UBS control device or UBS radio receiver.

Status indications	
Status display	Description
	Preset value for maintenance cycle counter reached.
	Dot on left is not lit: Control circuit has a short circuit or is overloaded.
	Function for changing the rotating direction is activated, only possible during initial operation.
	Change of rotating direction has been carried out, only possible during initial operation.
 Flashing	Programming option is blocked.
 Flashing	Teach in OPEN final limit position.
 Flashing	Teach in CLOSE final limit position.
 Flashing	UPWARDS travel active.
 Flashing	CLOSING operation active.
	Stop between the set final limit positions.
	Stop at the OPEN final limit position.
	Stop at the intermediate stop position.
	Stop at the CLOSE final limit position.
 Flashing	Blocking of programming option confirmed. Flashing display: Unblocking of programming option active.
	Interruption of the photo cell function: At first interruption of the light beam.
	Interruption of the photo cell function: When exiting the programming.

12 Explanation of symbols

Symbol	Explanation
	Prompt: Read installation instructions
	Prompt: Check
	Prompt: Note
	Prompt: Note the setting of the menu below
	Factory setting of the menu
	Factory setting of the menu, value on the right
	Factory setting of the minimum limit, dependent on drive unit
	Factory setting of the maximum limit, dependent on drive unit
	Setting range
	Prompt: Select menu item or value, turn selector switch S to the left or to the right
	Prompt: View menu item, press selector switch S once
	Prompt: Store, press selector switch S once
	Prompt: Start programming, actuate the selector switch S for three seconds

Symbol	Explanation
	Prompt: Setting via OPEN/CLOSE built in push-button; Use OPEN push-button to increase value, CLOSE push-button to decrease value
 1x	Prompt: Press stop button once via built in push-button
 1x	Prompt: Save, press stop button once via built in push-button
 3s	Prompt: Save, press stop button for three seconds via built in push-button
 3s	Prompt: Reset the control, press stop button for three seconds via built in push-button
	Prompt: Move to door position
	Prompt: Move to door position for OPEN final limit position
	Prompt: Move to pre-limit
	Prompt: Move to door position for CLOSE final limit position

Declaration of incorporation

within the meaning of Machinery Directive 2006/42/EC
for partly completed machinery, Appendix II Part B



Declaration of conformity

within the meaning of EMC Directive 2014/30/EU
within the meaning of RoHS Directive 2011/65/EU

GfA ELEKTROMATEN GmbH & Co. KG
Wiesenstraße 81 · 40549 Düsseldorf
Germany

We,
GfA ELEKTROMATEN GmbH & Co. KG
declare under our sole responsibility that the
following product complies with the above
directives and is only intended for installation in a
door system.

Door control
TS 970
Part no.: 20197000

We undertake to transmit in response to a
reasoned request by the appropriate regulatory
authorities the special documents on the partly
completed machinery.

This product must only be put into operation
when it has been determined that the complete
machine/system in which it has been installed
complies with the provisions of the above-
mentioned directives.

Authorised representative to compile the
technical documents is the undersigned.

Düsseldorf, 10.09.2019

Stephan Kleine
CEO

Signature

The following requirements from Appendix I of
the Machinery Directive 2006/42/EC are met:
1.1.2, 1.1.3, 1.1.5, 1.2.1, 1.2.2, 1.2.3, 1.2.4.2,
1.2.5, 1.2.6, 1.3.1, 1.3.2, 1.3.3, 1.3.4, 1.3.9,
1.5.1, 1.5.2, 1.5.4, 1.5.5, 1.5.6, 1.5.7, 1.5.8,
1.5.9, 1.5.10, 1.5.11, 1.5.13, 1.6.1, 1.6.2, 1.6.4,
1.7.1.1, 1.7.1.2, 1.7.2, 1.7.3, 1.7.4.3.

Standards applied:

EN 12453:2019

Industrial, commercial and garage doors and
gates - Safety in use of power operated doors -
Requirements

EN 12978:2003+A1:2009

Industrial, commercial and garage doors and
gates - Safety devices for power operated doors
and gates - Requirements and test methods

EN 60335-2-103:2015

Household and similar electrical appliances -
Safety - Part 2-103: Particular requirements for
drives for gates, doors and windows

EN 61000-6-2:2005

Electromagnetic compatibility (EMC) Part 6-2
Generic standards – Immunity standard for
industrial environments

EN 61000-6-3:2007

Electromagnetic compatibility (EMC) Part 6-3
Generic standards – Emission standard for
residential, commercial and light-industrial
environments